

2

1

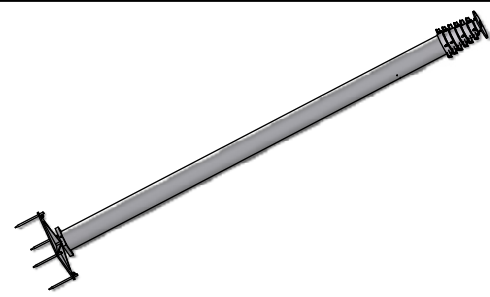

PLATFORM WITH GUY HOLES

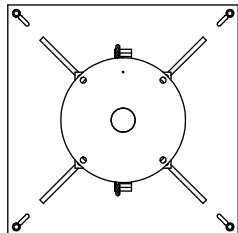
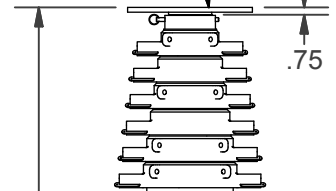

Ø13.0

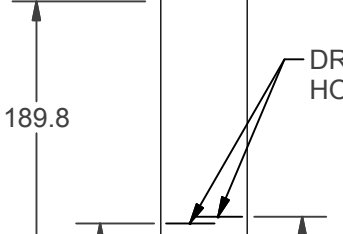

DRAIN HOLES

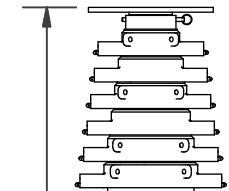

208.9

189.8

205.4

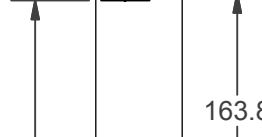

163.8



AIR INLET

BASE ASSEMBLY

12" BASE STAKE (4) PL.

GROUND LEVEL

11.5

3.5

Ø9.0

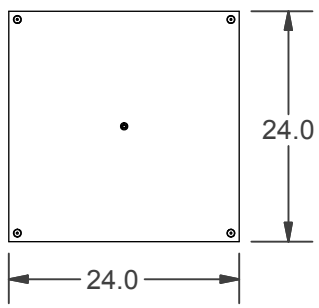

PROPRIETARY AND CONFIDENTIAL
 THE INFORMATION CONTAINED IN THIS DRAWING IS THE SOLE PROPERTY OF THE WILL-BURT COMPANY ANY REPRODUCTION IN PART OR WHOLE WITHOUT THE WRITTEN PERMISSION OF THE WILL-BURT COMPANY IS PROHIBITED.



AN EMPLOYEE OWNED COMPANY
 WILL-BURT
 ORRVILLE, OH

UNLESS OTHERWISE SPECIFIED DIMENSIONS ARE IN INCHES

ALL DIMENSIONS ARE REFERENCE
 THIRD ANGLE PROJECTION

TITLE **PNEUMATIC MAST
 INSTALLATION DIMENSIONS**

MODEL **17-100-468
 FIELD MOUNT**

JUNR-07

2

1

